

# BALDWIN®

## *Installation Instructions* ENGLISH

*Interior Latchset*  
PRIVACY (Bed & Bath)  
PASSAGE (Hall & Closet)



- |   |   |   |  |
|---|---|---|--|
| Classic Knob<br><br>5405    | Colonial Knob<br><br>5410       | Contemporary Knob<br><br>5415 | Egg Knob<br><br>5425       |
| Fillmore™ Knob<br><br>5800 | Dorchester® Knob<br><br>5805   | Peyton® Knob<br><br>5820     | Kelham® Knob<br><br>5810  |
| Ashbury® Lever<br><br>5845  | Contemporary Lever<br><br>5460 | Colonial Lever<br><br>5440   | Classic Lever<br><br>5445 |
| Scroll Lever<br><br>5450   | Wave Lever<br><br>5455         |   |  |

### Remember Baldwin

With the completion of your project, remember that Baldwin quality hardware products are available for all your decorating and remodeling needs. Matching entrance sets for exterior doors, beautiful bath accessories, and a complete selection of cabinet and door-enhancing hardware are all available from your Baldwin retailer.

To request a product brochure or the name of a retailer near you, call 1-800-566-1986.

### Congratulations!

With your purchase of this Interior Latchset, you're among a group of discerning individuals who know the intrinsic value of selecting the finest—Baldwin.

Our step-by-step installation instructions will help guide you through your project quickly and easily.

Before you begin your installation, read and understand the installation instructions and marking templates. If you have any questions, please do not hesitate to contact our Baldwin Consumer Help Line at 1-800-566-1986. We're here to help! We thank you for your purchase and wish you the fullest enjoyment of your Baldwin product.

### Care and Maintenance

**WARNING:** Do not attempt to clean your hardware with any type of abrasive cleaners, solvents, or chemicals. These types of cleaning agents may mar the finish. A damp cloth is all that is necessary to wipe clean.

Note: Finish Number 102, Oil-Rubbed Bronze, can be cleaned with light machine oil and wiped with a dry cloth.



Baldwin offers a vast array of exceptional solid brass products to elegantly enhance all areas of the home. Each collection features a wide variety of beautiful, high-fashion finishes. From door hardware to bath accessories, Baldwin provides the discriminating decorator with numerous options to accent and complement the home's ambience with distinction, taste, and fine detail.

### Consumer Help Line 1-800-566-1986

Hours: 8 a.m. to 8 p.m. E.S.T - Monday - Friday  
10 a.m. to 6 p.m. E.S.T - Saturday

If you have trouble installing your Baldwin product, feel free to call our toll-free Consumer Help Line.

# BALDWIN

© Baldwin Hardware Corporation  
841 East Wyomissing Blvd, Reading, PA 19611

Browse through the Baldwin Collection of beautiful locks, bath accessories and decorative hardware. Compare styles and finishes. There are thousands of photos and descriptions available to help you coordinate hardware throughout your home. Create your ideal "wish list" then visit your Baldwin Retailer or Dealer. Visit [www.baldwinhardware.com](http://www.baldwinhardware.com) today!

[www.baldwinhardware.com](http://www.baldwinhardware.com)

## Required Tools



Protective Eyewear



Phillips Screwdriver

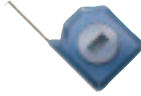

Tape Measure



2 1/8" Dia. Face Bore Hole Saw



Electric Drill

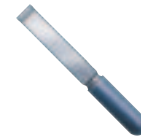

1/2" Wood Chisel



1/8" Wood Drill Bit



7/8" Spade Bit



Pencil



Utility Knife



Masking Tape

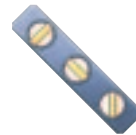

24" Level

## Helpful Tools



Hammer



Wood Filler



Beeswax or Soap



Flat Head Screwdriver

# 1 Before You Begin

- Check the thickness of the door. This lockset works on 1 3/8" and 1 1/4" thick doors only.
- **Follow the step-by-step sequence to ensure proper operation of your Baldwin lockset.**
- If your door is pre-drilled, see latchset installation step 1. If it is not pre-drilled, see door preparation step 1. **Caution:** Images Full Dummy and Half Dummy trim are not designed to be installed on a door with a 2 3/8" face bore. If your door is pre-bored, contact our Consumer Help Line at 1-800-566-1986 for assistance.
- **Important!** If you are removing an old lock and replacing it with a Baldwin lockset, you must install the Baldwin strikeplate provided. Failure to do so could void your warranty. You may need to plug existing holes left by the old strikeplate screws with wood dowels and re-drill the pilot holes for the new strikeplate.
- If the hand (direction of the latch bolt) of a privacy latch must be changed for the intended application, see latchset installation step 1.
- Pressing in the privacy button from the inside locks Baldwin privacy latches. The outside knob or lever is rigid when the latch is locked. From the inside, turning the knob or pressing down on the lever opens the door. The privacy latch can't be locked from the outside. If the button is inadvertently pressed in while exiting the room, the privacy button will release when the latch bolt hits the strikeplate. Contact our Consumer Help Line at 1-800-566-1986 if you have any questions concerning the operation of your Baldwin hardware.
- 2 3/8" backset privacy latches for use with knobs are supplied with privacy buttons for 1 3/8" thick doors. If you are installing these latches on a 1 1/4" thick door you will need to install the privacy button extender.
- We recommend spreading cardboard over floor to prevent scratching parts and marring floor.
- Always wear protective eyewear.

## Determining the Backset

Prior to installation you must verify that you have purchased the correct backset. Backset is the distance from the edge of the door to the center of the hole in the face of the door. There are two common backsets: 2 3/8" and 2 1/4". This lock is shipped with a 2 3/8" or a 2 1/4" backset.



**Note:** The illustrations in these instructions depict the outside handle being installed on the right of the door. For installation of the outside handle on the left of the door, proceed as if all illustrations were reversed.

## Exploded View

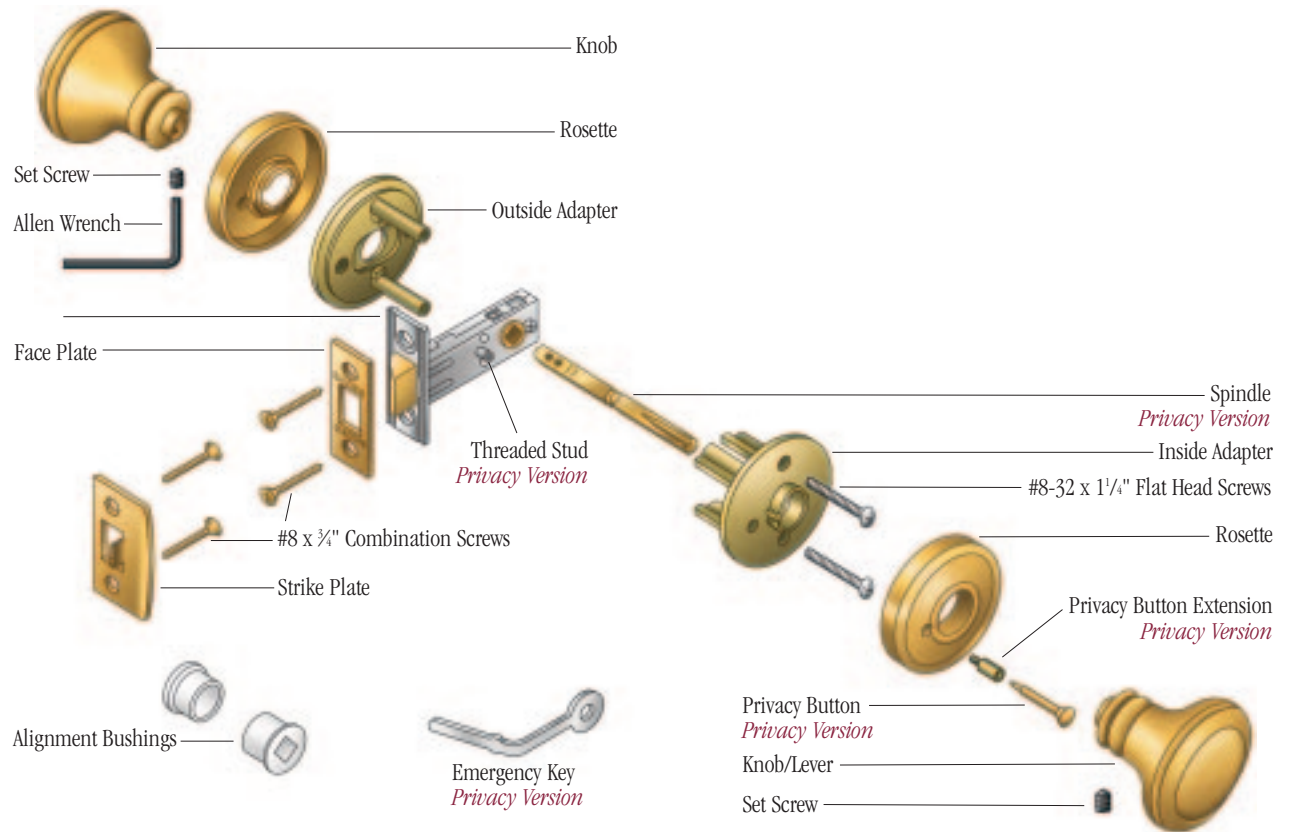

## Handleset Installation Fasteners

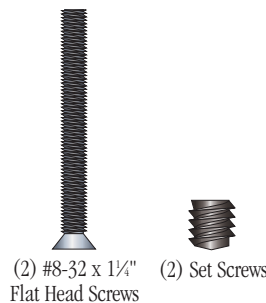

## Strikeplate Installation Fastener

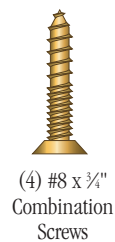

## Privacy Version

If it is necessary to enter a locked room, place the emergency key supplied through the hole in the rosette on the outside and press in. This will push the privacy pin into the unlocked position, allowing access to room from outside.



# Door Hole Template

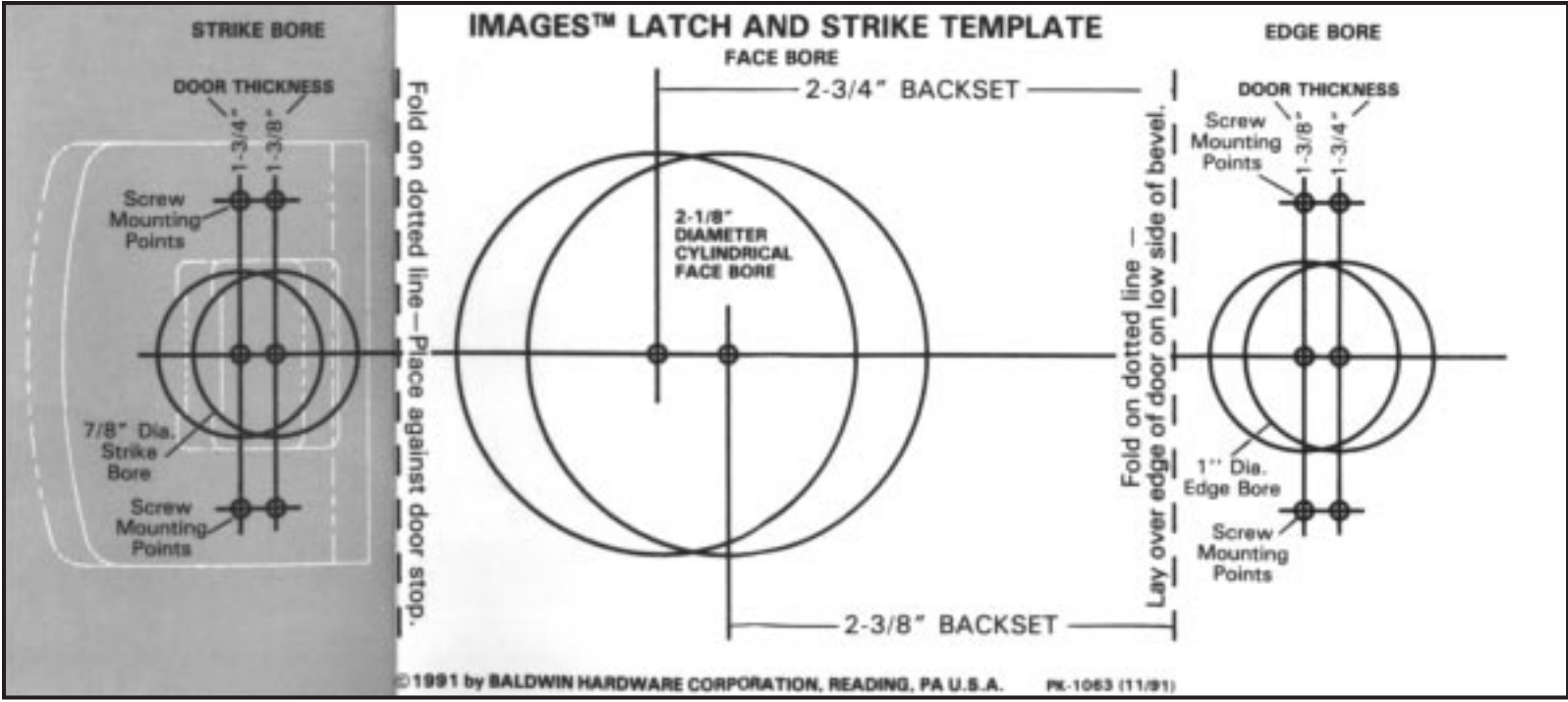

## 2 Latchset Installation

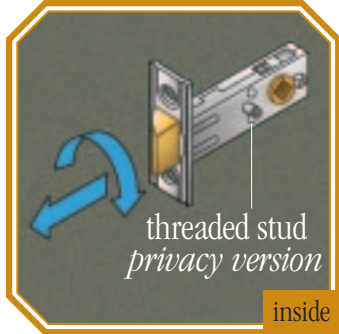

**1** Slide latch into door with threaded stud for privacy version facing inside. The curved side of the latchbolt must face the doorframe. If needed, latchbolt can be reversed by pulling the bolt out, rotating one half turn, and releasing.



**2** Insert latch and drill  $\frac{1}{8}$ " pilot holes for combination screws.



**3** Slide faceplate over latch bolt and secure with #8 x  $\frac{3}{4}$ " combination screws. **Helpful Hint:** When installing wood screws it is recommended to put beeswax or soap on screw threads to improve installation.



**4** Install the inside adapter. Install the outside adapter. Insert #8-32 x  $\frac{1}{4}$ " flat head screws, but do not tighten them at this time.



**5** Insert spindle through latch so ends protrude from both adapters. Slide the alignment bushings onto each end of spindle and into bore of adapters.



## 2 Latchset Installation (contd.)



**6** Tighten screws, then remove alignment bushings and discard. Remove spindle from latch.

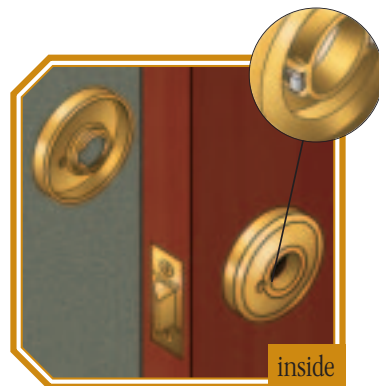

**7** Snap inside and outside rosettes into place.  
**Privacy Version:** Privacy hole should face door edge and align with threaded stud.



**8 Privacy Version Only**  
Insert privacy button into hole on inside rosette and thread it into latch. If needed, use privacy button extension.

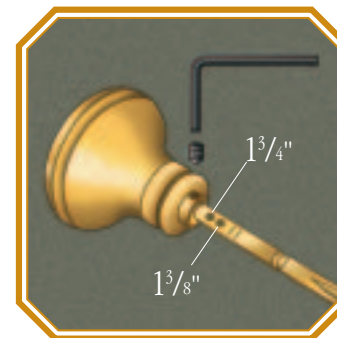

**9** Insert spindle into knob/lever and align set screw hole over the marked side of spindle for your door thickness. Tighten set screw with Allen wrench.



**10** Insert spindle into rosette. Position V groove down and toward door hinges.

## 2 Latchset Installation (contd.)

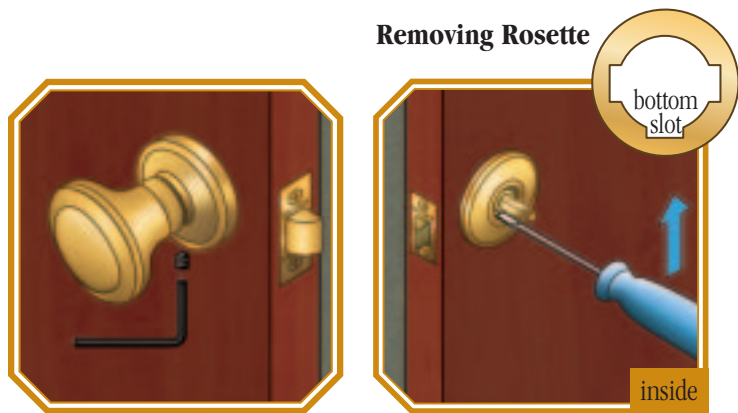

**11** While holding inside knob/lever, push outside knob/lever against rosette. Align hole in handle with V groove in spindle. Insert set screw and tighten with Allen wrench provided.

If you need to remove rosettes after installation, loosen set screw and remove knob/lever and spindle. Place flat head screwdriver into bottom slot of rosette and pry off.

### 3 Strikeplate Installation

**IMPORTANT!** You must install Baldwin strikeplate or your warranty is void.



**1** Carefully swing door to closed position. Mark exact center point where latch meets the doorframe.



**2** Determine door thickness. Use template to mark screw holes and correct center points for door thickness.



**3** Use masking tape to mark 1" from edge of spade bit. Drill  $\frac{7}{8}$ " diameter hole 1" deep at center point.



**4** Align strikeplate holes with marks. Score chisel guide into doorframe with utility knife.



**5** Chisel within score marks  $\frac{1}{16}$ " deep cavity or until strikeplate is flush with wood.



### 3 Strikeplate Installation (contd.)

**IMPORTANT! You must install Baldwin strikeplate or your warranty is void.**



6 Using strike as a template, drill  $\frac{1}{8}$ " pilot holes for #8 x  $\frac{3}{4}$ " combination screws.



7 Secure strikeplate into position with #8 x  $\frac{3}{4}$ " combination screws.

**Helpful Hint:** When installing wood screws it is recommended to put beeswax or soap on screw threads to improve installation.

## 4 Door Preparation (If Needed)



**1** Pull door toward you to check if it's level. Observe contact of door to jam and make sure it's level. Adjust if necessary.

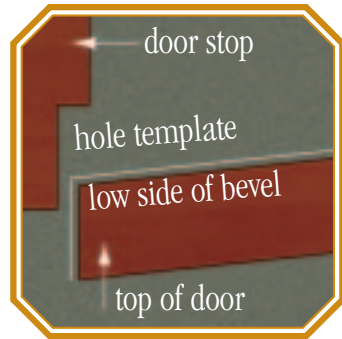

**2** (Aerial View) To ensure proper alignment, only use hole template on side facing doorstop.  
**Helpful Hint:** Some doors have a beveled edge with bevel facing doorstop.



**3** Fold hole template along door edge with face bore center point 40" from floor. Tape template to door. Use template to mark the backset center point and edge bore center point.

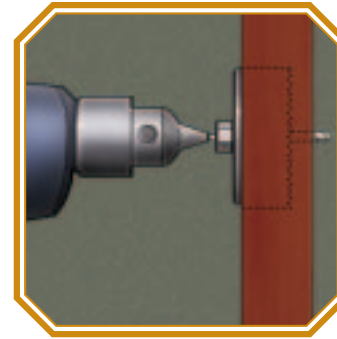

**4 Face Bore:** Very carefully drill 2 1/8" hole into one side of door face exactly at pencil marks until drill bit starts to protrude on opposite side.  
**Important:** Drill perpendicularly (at a 90° angle) to door.

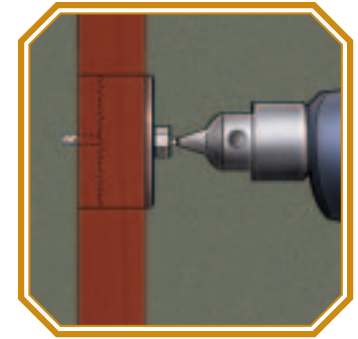

**5** Complete drilling hole from opposite side of door.

## 4 Door Preparation (If Needed) contd.



**6 Edge Bore:** Very carefully drill 1" holes into door edge exactly at pencil marks.



**7** Insert latch into hole. Use utility knife to score chisel guides into door edge. Make sure score lines are parallel to door.



**8** Chisel faceplate cavity  $\frac{1}{8}$ " deep.  
**Helpful Hint:** Chisel toward inside edge of score lines, removing only a small bit to avoid wood damage.

## Troubleshooting Guide

If parts are missing do not return product. Please call Baldwin's Consumer Help Line at 1-800-566-1986 and we will quickly send the parts to you.

Problem	Solution
Knob or lever will not come up to the horizontal or center position.	Product is out of alignment. Remove knobs or levers and loosen screws on adapter. Insert alignment bushings and tighten adapter screws. Remove alignment bushings and discard. Install rosettes and knobs or levers. If product still binds, ensure that door is prepared to specification. Refer to latchset installation step 5.
Knob or lever pulls off the spindle.	Set screws not located in dimple on one side of spindle or V groove on other. Epoxy patch (red spot) on set screw too large to allow screw to thread in against spindle. Knob or lever not tapped correctly, polishing compound in threads. Clean out by threading a 1/4" x 20 flat bottom tap into knob or lever. Refer to latchset installation step 9. Contact your Baldwin distributor for a replacement or call 1-800-566-1986 for assistance.
Privacy latch is the wrong hand.	Before installing latch, hold body of latch in one hand. Pull out the latch bolt and rotate it 180°. Refer to latchset installation step 1.
Can't remove rosettes for painting.	If rosette has a notch, pry the rosette off with a small screwdriver. Care must be taken to ensure that finish is not damaged. Refer to removing rosette section in latchset installation.
Rosettes are loose and rattle when door closes.	Remove knobs (or levers) and rosettes. Use a small screwdriver to spread steel springs which rosette attaches to slightly. Care must be taken not to spread them too far or they will bend when rosette is installed again.