

# DOOR AND JAMB DETAIL

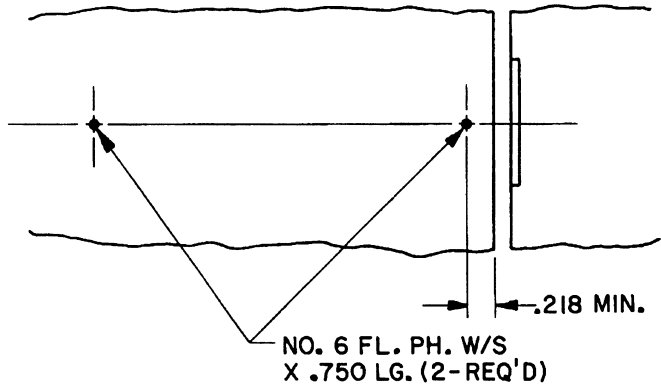

# BOLT DETAIL

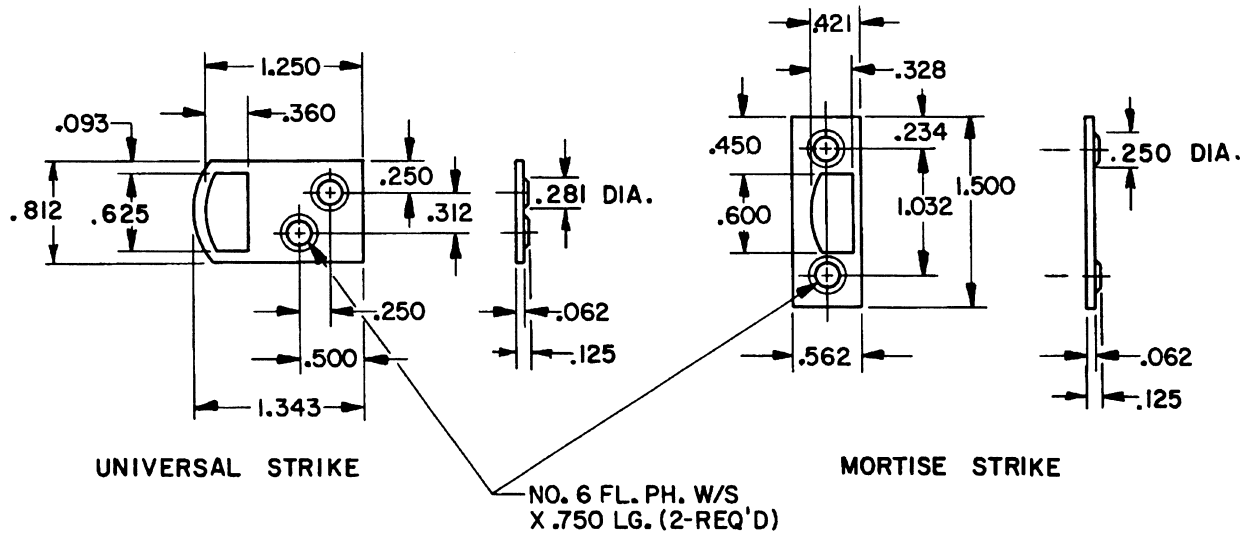
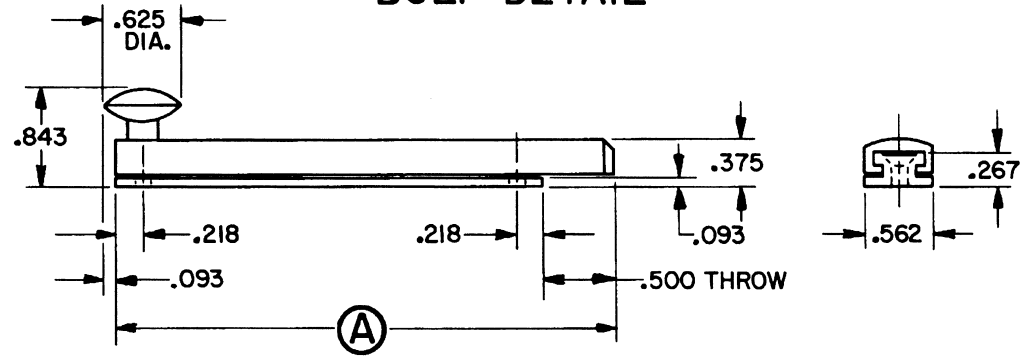

PART NO.	0322
DIMENSION (A)	4.00
<b>BALDWIN</b>	
<b>SURFACE BOLTS</b>	
TEMPLATE NO. VARIATIONS	TEMPLATE NO.
	<b>A134</b>

EFFECTIVE: 9-1-86 R.M.S.

DO NOT SCALE DRAWING

©1986 by Baldwin Hardware Corporation